

Stalldunggabel

Zum Anbau an Hof-, Rad- und Teleskoplader
Breite 1450 mm / Zinken 8

Art.Nr.: SDGHRT000001V

Manure fork

For attachment to farm, wheel or telescopic
Width 1450 mm / tins 8

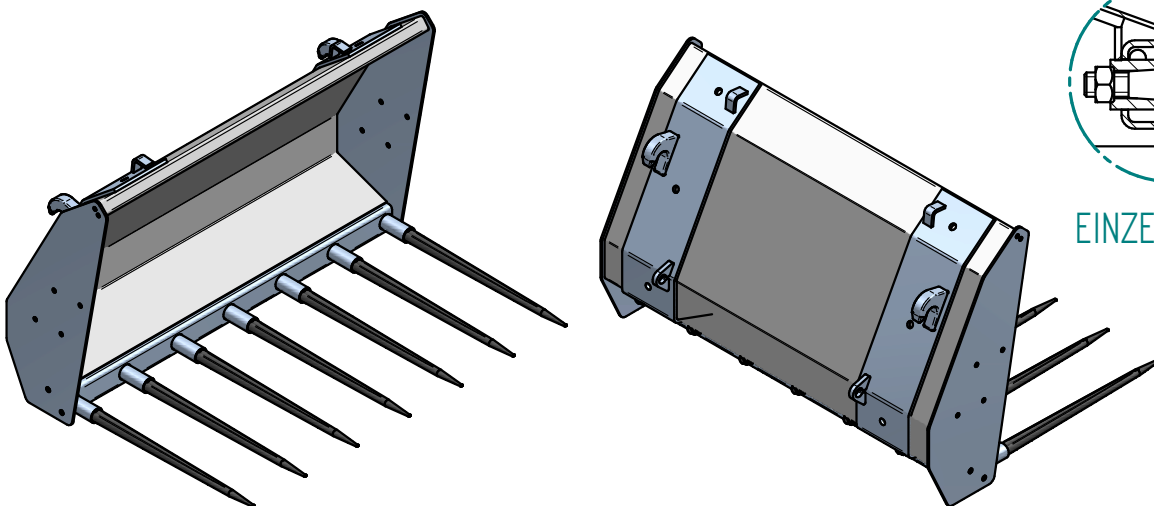
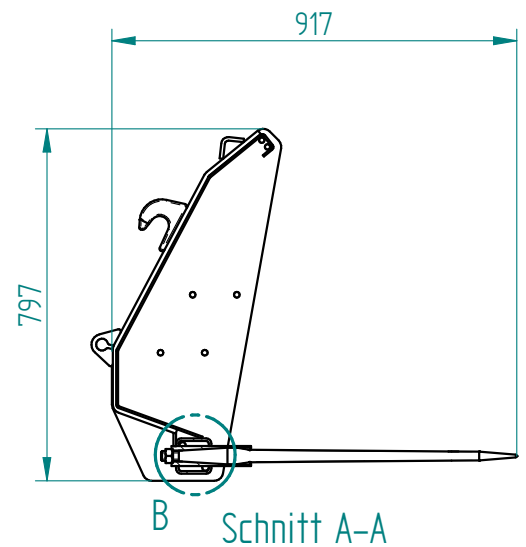
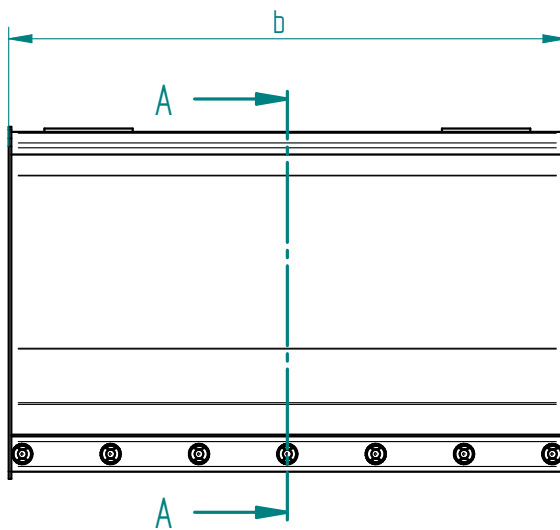

*Irtümer, technische Änderungen vorbehalten. | Technical modifications and errors excepted.

Fliegl Agro-Center GmbH · Maierhof 1 · D-84556 Kastl
Tel. +49 (0)8671/9600-0 · Fax +49 (0)8671/9600-701 · info@agro-center.de

www.agro-center.de

