

Stalldunggabel

Zum Anbau an Euronorm / Breite 1650 mm / Zinken 9

Art.Nr.: SDGFLM000002V

Manure fork

For attachment to Euronorm / Width 1650 mm / tins 9

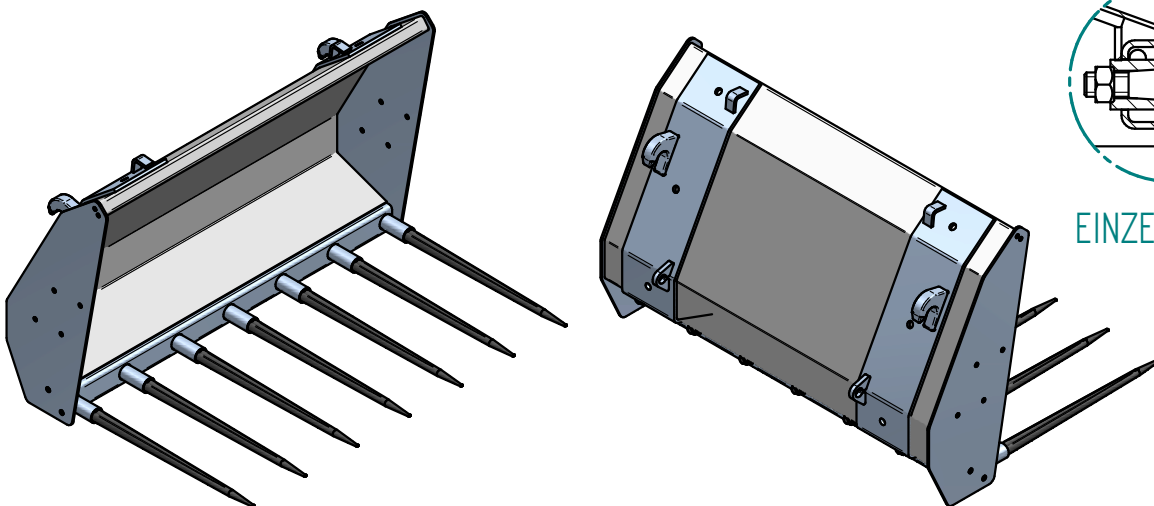
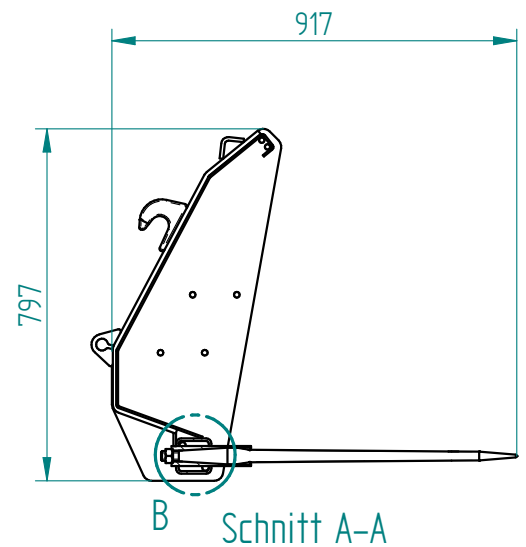
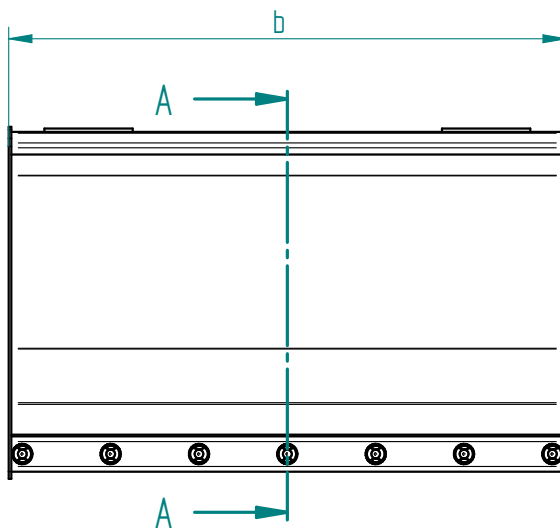

*Irtümer, technische Änderungen vorbehalten. | Technical modifications and errors excepted.

Fliegl Agro-Center GmbH · Maierhof 1 · D-84556 Kastl
Tel. +49 (0)8671/9600-0 · Fax +49 (0)8671/9600-701 · info@agro-center.de

www.agro-center.de

