

Datenblatt

Ölmotor CLS 315

Artikelnummer: HMTXXX100070

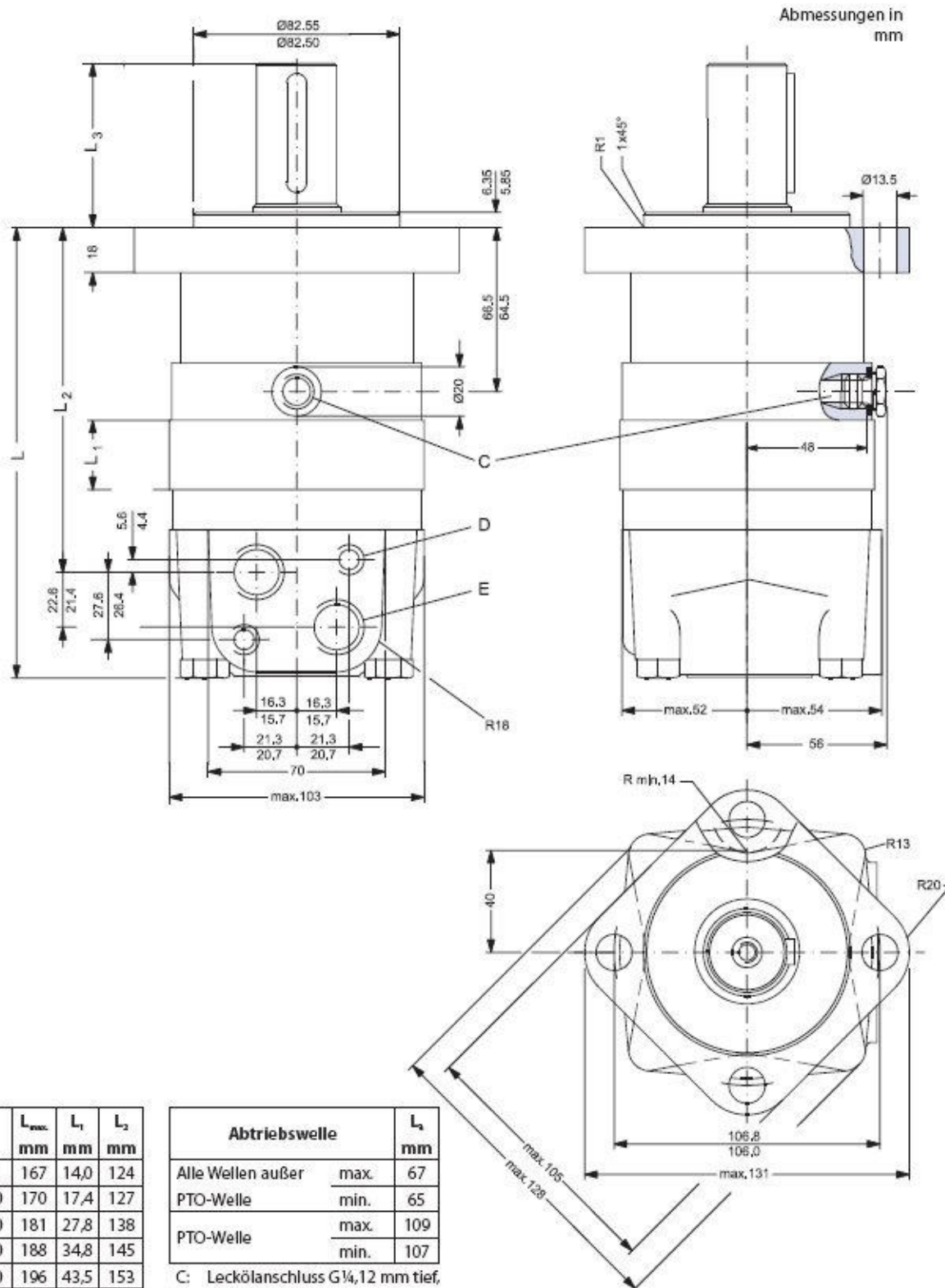

Typ	L_{max} mm	L_1 mm	L_2 mm
CLS 80	167	14,0	124
CLS 100	170	17,4	127
CLS 160	181	27,8	138
CLS 200	188	34,8	145
CLS 250	196	43,5	153
CLS 315	208	54,8	165

Abtriebswelle		L_3 mm
Alle Wellen außer PTO-Welle	max.	67
	min.	65
PTO-Welle	max.	109
	min.	107

C: Leckölanschluss $G\frac{1}{4}$, 12 mm tief,

D: M10, 13 mm tief,

E: $G\frac{1}{2}$, 15 mm tief