

Dung- und Silagegreifschaufel

1850 mm / zum Anbau an Hof-, Rad- oder Teleskoplader

Manure and silage grab fork

1850 mm / for attachment to farm, wheel or telescopic loader

Art.Nr.: DSGHRT180000V

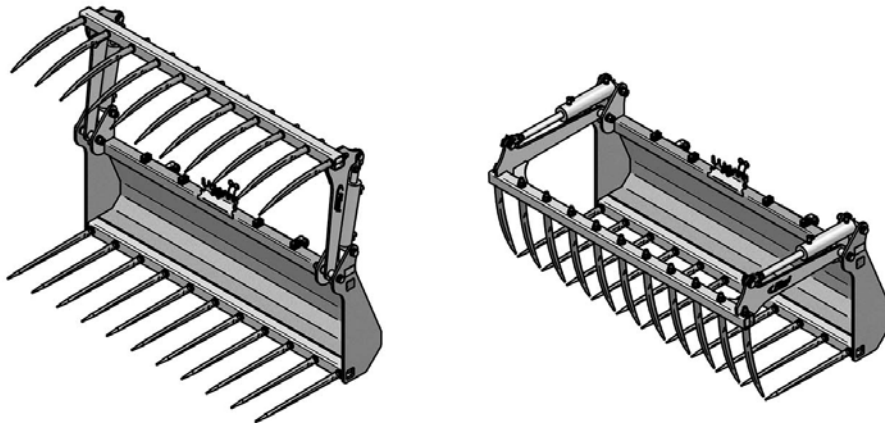
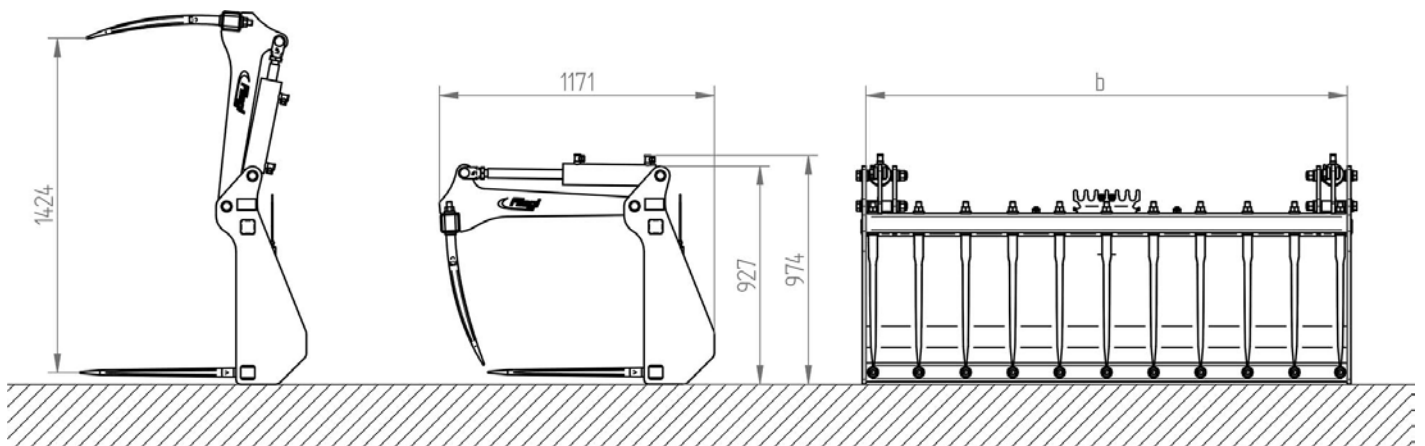

Breite (b)
1250mm
1450mm
1650mm
1850mm
2050mm
2250mm

*Irrtümer, technische Änderungen vorbehalten. | Technical modifications and errors excepted.

Fliegl Agro-Center GmbH · Maierhof 1 · D-84556 Kastl
Tel. +49 (0)8671/9600-0 · Fax +49 (0)8671/9600-701 · info@agro-center.de

www.agro-center.de

